



浙江芯芯电子有限公司  
ZHEJIANG XINXIN ELECTIRICAL CO., LTD.

# 产品规格书

## Specification of Products

产品名称：平板型

产品型号：2000A

浙江芯芯电子有限公司

ZHEJIANG XINXIN ELECTIRICAL CO., LTD.

地址：浙江省缙云县壶镇镇浙江丽缙五金科技产业园苍山区块内

电话：13857067071

邮编：321404

E-mail:247145749@qq.com

<http://www.zjxxdz1.com>

拟制	审核	核准
丁国盛	李园利	麻伟阳

版本号：04 更新日期：2022.6.28

SYMBOL	CHARACTERISTIC	TEST CONDITIONS	T <sub>j</sub> (C)	VALUE			UNIT	
				Min	Type	Max		
I <sub>F(AV)</sub>	Mean forward current	180 half sine wave 50Hz Double side cooled, T <sub>CS</sub> =55 C	150			3098	A	
I <sub>F(AV)</sub>	Mean forward current	180 half sine wave 50Hz Double side cooled, T <sub>CS</sub> =90 C	150			2289	A	
V <sub>RRM</sub>	Repetitive peak reverse voltage	V <sub>RRM</sub> tp=10ms V <sub>RSM</sub> = V <sub>RRM</sub> +100 V	150	3100		3800	V	
I <sub>RRM</sub>	Repetitive peak current	at V <sub>RRM</sub>	150			160	mA	
I <sub>FSM</sub>	Surge forward current	10ms half sine wave	150			40.3	KA	
I <sup>2</sup> T I	I <sup>2</sup> T for fusing coordination	V <sub>R</sub> =0.6V <sub>RRM</sub>					8110	A <sup>2</sup> s*10 <sup>3</sup>
V <sub>FO</sub>	Threshold voltage		150			0.85	V	
r <sub>F</sub>	Forward slope resistance						0.14	mΩ
V <sub>FM</sub>	Peak on-state voltage	I <sub>TM</sub> =5400A, F=35KN	150			1.61	V	
I <sub>rm</sub>	Reverse recovery current		150			180	A	
t <sub>rr</sub>	Reverse recovery time	I <sub>TM</sub> =1000A, tp= 1000 s, di/dt=40A/s, V <sub>R</sub> =50V					7.6	s
Q <sub>rr</sub>	Recovery charge						684	C
R <sub>th(j-h)</sub>	Thermal resistance Junction to heatsink	At 180° sine double side cooled Clamping force 35KN				0.016	C/W	
F <sub>m</sub>	Mounting force			30		40	KN	
T <sub>stg</sub>	Stored temperature			-40		160	C	
W <sub>t</sub>	Weight				900		g	
Outline	ZT60cT70							

Outline

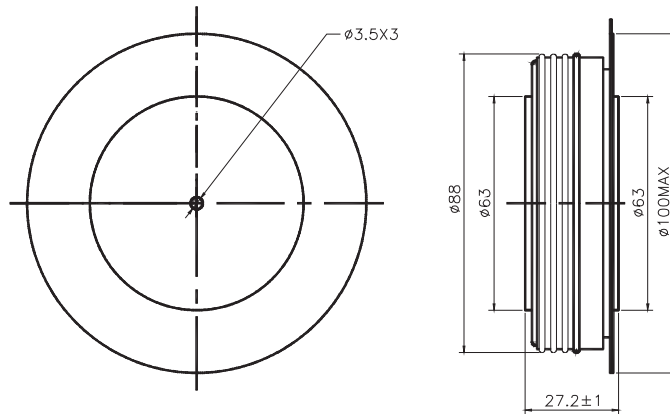

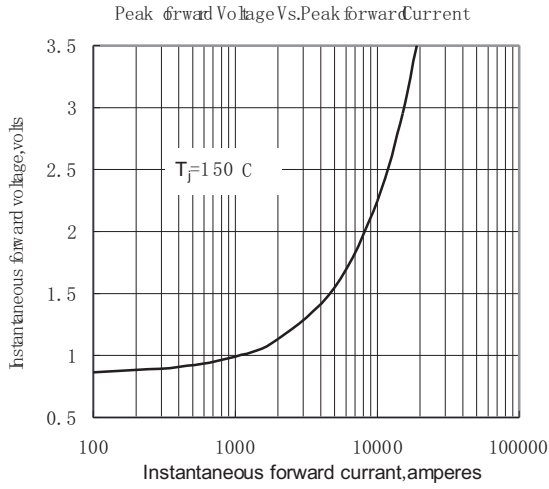

Fig. 1

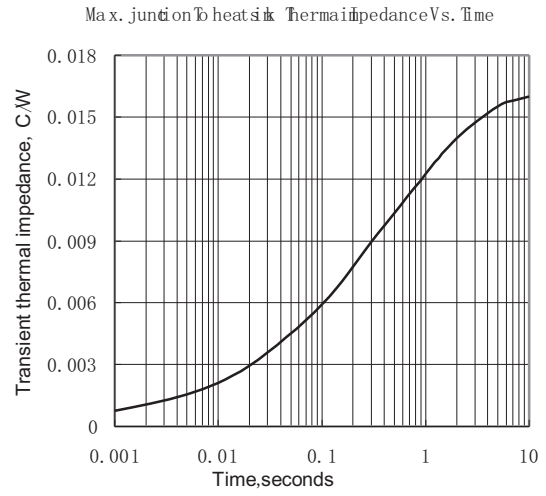

Fig. 2

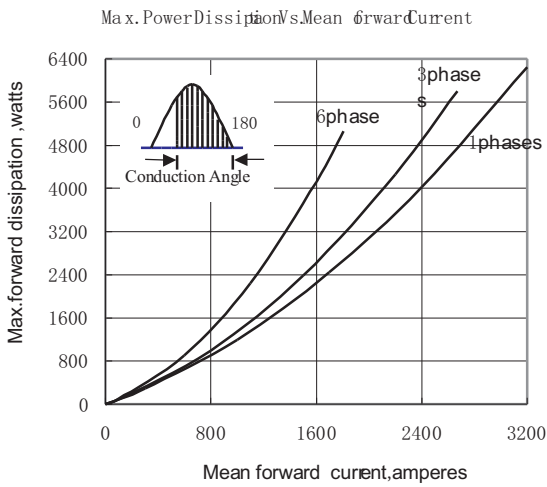

Fig. 3

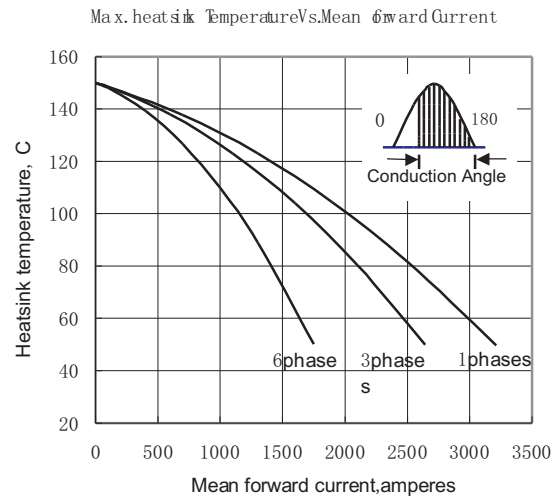

Fig. 4

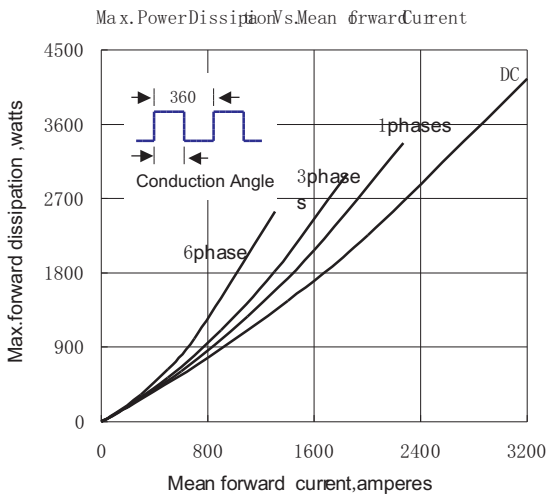

Fig. 5

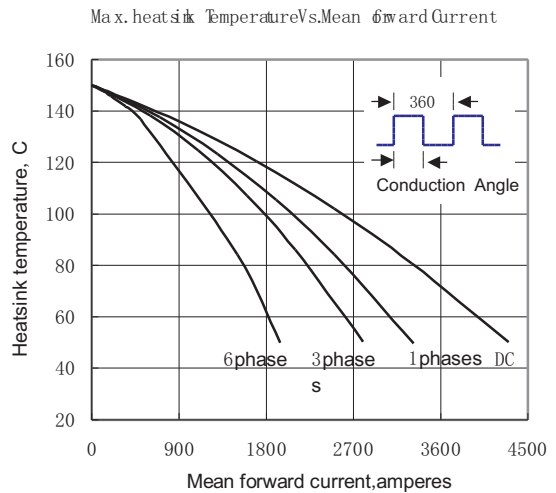

Fig. 6