



浙江芯芯电子有限公司
ZHEJIANG XINXIN ELECTIRICAL CO., LTD.

产品规格书

Specification of Products

产品名称：三相整流桥模块

产品型号：MDS100A

浙江芯芯电子有限公司

ZHEJIANG XINXIN ELECTIRICAL CO., LTD.

地址：浙江省缙云县壶镇镇浙江丽缙五金科技产业园苍山区块内

电话：13857067071

邮编：321404

E-mail:247145749@qq.com

<http://www.zjxxdz1.com>

拟制	审核	核准
丁国盛	李园利	麻伟阳

版本号：04 更新日期：2022.6.28

SYMBOL	CHARACTERISTIC	TEST CONDITIONS	T _j (°C)	VALUE			UNIT
				Min	Type	Max	
I _O	DC output current	Three-phase full wave rectifying circuit, T _C =100°C	150			100	A
V _{RRM}	Repetitive peak reverse voltage	V _{RRM} tp=10ms V _{RSM} = V _{DRM} &V _{RRM} +200V	150	600		2200	V
I _{RRM}	Repetitive peak current	at V _{RRM}	150			10	mA
I _{FSM}	Surge forward current	10ms half sine wave	150			1.5	KA
I ² t	I ² T for fusing coordination	V _R =0.6V _{RRM}				11.4	A ² s*10 ³
V _{FO}	Threshold voltage		150			0.80	V
r _F	Foward slop resistance					4.5	mΩ
V _{FM}	Peak forward voltage	I _{FM} =100A	25			1.1	V
R _{th(j-c)}	Thermal resistance Junction to heatsink	Single side cooled				0.240	°C /W
V _{iso}	Isolation voltage	50Hz,R.M.S,t=1min,I _{iso} :1mA(max)		2500			V
F _m	Terminal connection torque(M5)				2.0		N.m
	Mounting torque(M6)				3.0		N.m
T _{stg}	Stored temperature			-40		125	°C
W _t	Weight				154		g
Outline							

OUTLINE DRAWING & CIRCUIT DIAGRAM

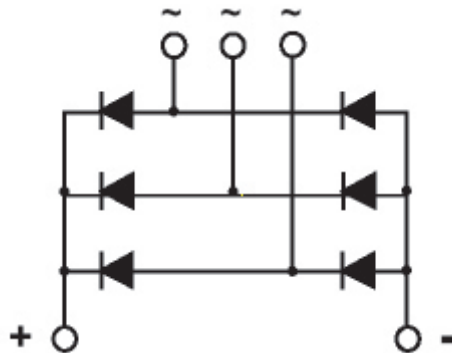

Rating and Characteristic

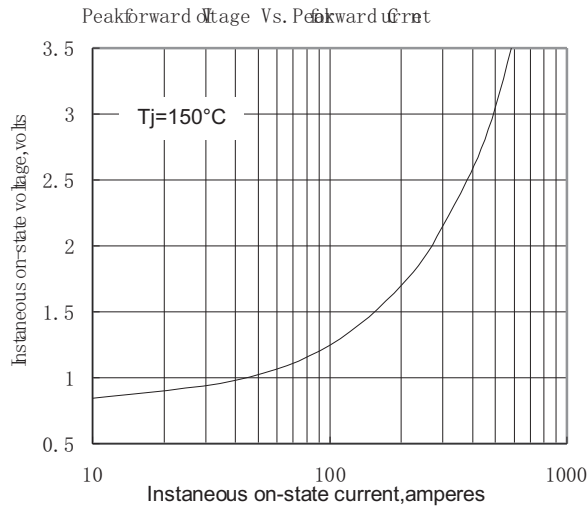

Fig.1

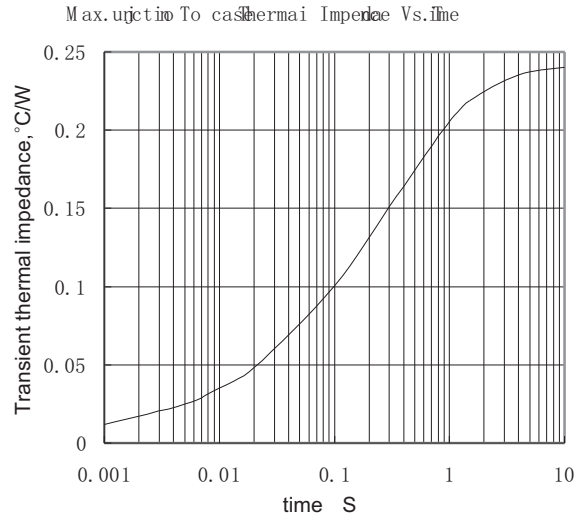

Fig.2

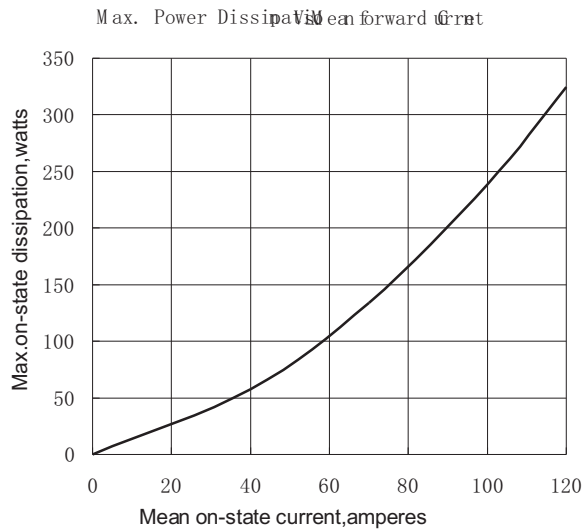

Fig.3

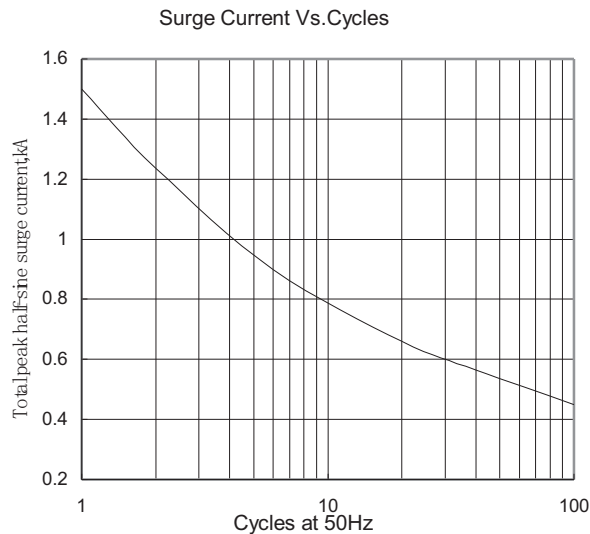
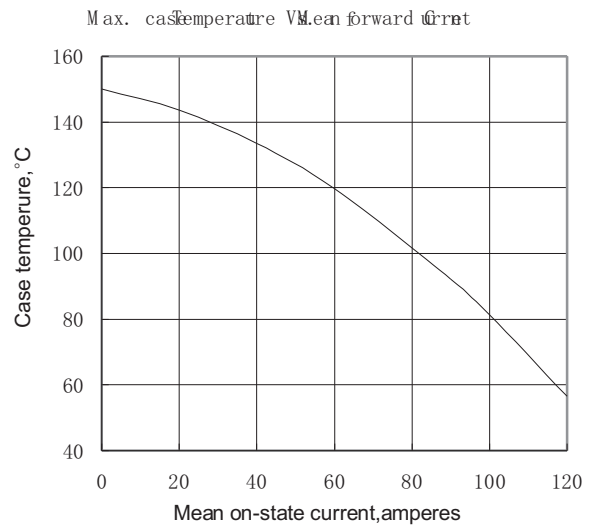

Fig.5

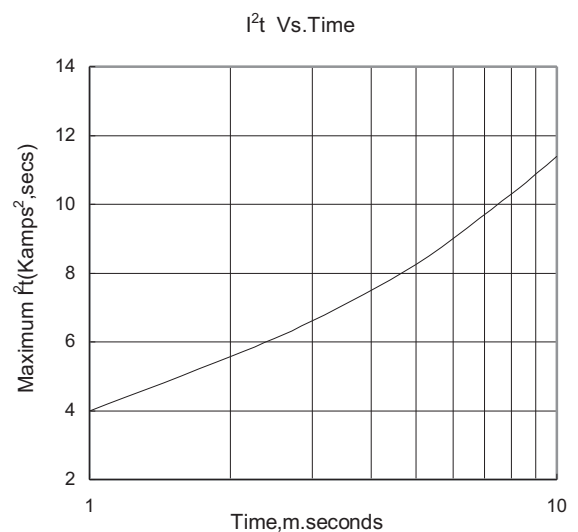

Fig.6

Outside Dimension

